

Revision Notes.

Checked By: - Approved By: - Date Released: -

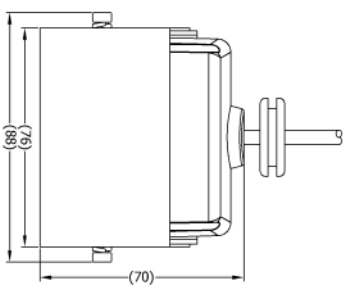

ITEM	STOCK CODE	QTY	DESCRIPTION
1	(#3906)	1	VBV-790C(92) C CAMERA ONLY
2	(#3189A)	1	VBV-71XX-C BRKT CAMERA BRACKET
3	(#3189A)	1	VBV-71XX-C SS CAMERA SUSPENDED
4	(#3191)	1	VBV-71XX-C SS CAMERA SHAWK
5	(#3907)	1	VBV-790C(92) IG. INSTALLATION GUIDE (NOT SHOWN)

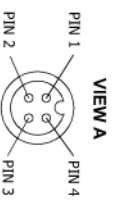
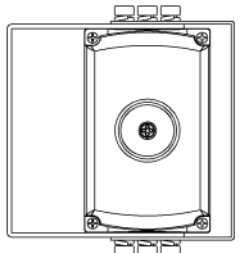
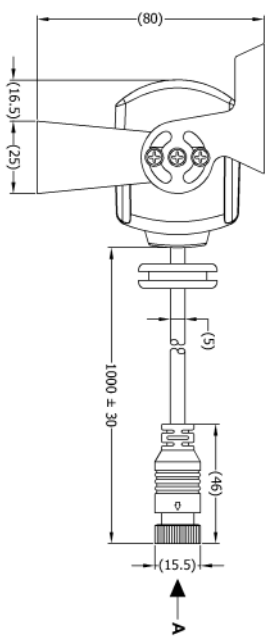
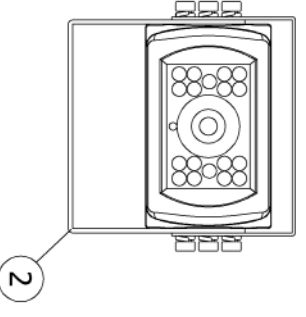
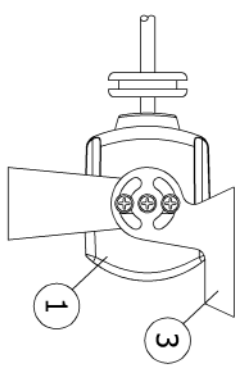
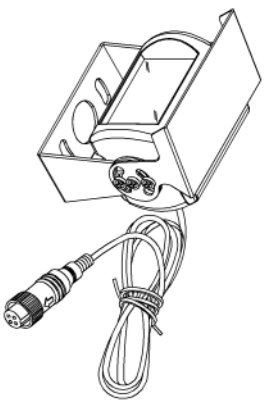

PIN #	WIRE COLOR	DESCRIPTION
1	RED	12 VDC
2	BLACK	GROUND
3	WHITE	NO CONNECTION
4	YELLOW	VIDEO

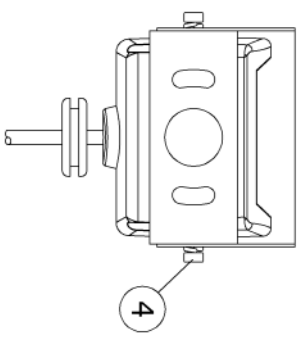

- NOTES:
1. REFER TO "PRODUCT SPECIFICATION" FOR MORE DETAILS.
 2. REFER TO COMPONENT DRAWINGS FOR COMPONENT DETAILS.
 3. FOR SERIAL NUMBER LABEL REFER TO DRAWING NUMBER: BE-001324-XX-10.
 4. FOR PRODUCT LABEL REFER TO DRAWING NUMBER: BE-001647-XX-11.

PROPRIETARY NOTICE
 THIS DESIGN AND TECHNICAL INFORMATION APPEARING ON THIS DRAWING IS THE PROPERTY OF BRIGADE ELECTRONICS, AND IS DISCLOSED IN CONFIDENCE. IT IS NOT TO BE COPIED, REPRODUCED, REVEALED TO OR EXPLOITED BY OTHERS, EITHER IN WHOLE OR IN PART WITHOUT THE EXPRESS WRITTEN CONSENT OF BRIGADE ELECTRONICS.

BRIGADE
 www.brigade-electronics.com

Assembly Pt Approval	Approved by	Checked by	Drawn by
-	D.KERAL	L.BRAR	JNEWMAN
Angle of Projection	Units	Scale	Released
Third Angle	mm	N/A	24/06/11
Status	Released	Assembly Ref	
RELEASED			VBV-790C(92)
Stock Code			BE-001645-00-11
#3905			